

Межгосударственный стандарт

**Детали трубопроводов бесшовные приварные
из углеродистой и низколегированной стали**

**ОТВОДЫ КРУТОИЗОГНУТЫЕ
ТИПА 3D (R ≈ 1,5 DN)**

Конструкция

Издание официальное

Предисловие

1. РАЗРАБОТАН ОАО «Корпорация МОНТАЖСПЕЦСТРОЙ»

ВНЕСЕН Государственным комитетом Российской Федерации по стандартизации и метрологии.

2. ПРИНЯТ Межгосударственным советом по стандартизации, метрологии и сертификации (протокол № 20 от 1 ноября 2001 г.)

За принятие проголосовали:

Наименование государства	Наименование национального органа по стандартизации
Азербайджанская Республика	Азгосстандарт
Республика Армения	Армгосстандарт
Республика Беларусь	Госстандарт Республики Беларусь
Грузия	Грузстандарт
Республика Казахстан	Госстандарт Республики Казахстан
Кыргызская республика	Кыргызстандарт
Республика Молдова	Молдовастандарт
Российская федерация	Госстандарт России
Туркменистан	Главгосслужба «Туркменстандартлары»
Республика Узбекистан	Узгосстандарт
Украина	Госстандарт Украины

3. Стандарт соответствует ИСО 3419-81 «Фитинги и легированной и нелегированной стали приварные встык» в части конструкции отводов.

4. Постановление Государственного комитета Российской Федерации по стандартизации и метрологии от 27 мая 2002 г. № 205-ст межгосударственный стандарт ГОСТ 17375-2001 (ИСО 3419-81) введен в действие непосредственно в качестве государственного стандарта Российской Федерации с 1 января 2003 г.

5. ВЗАМЕН ГОСТ 17375-83

Межгосударственный стандарт

Детали трубопроводов бесшовные приварные из углеродистой и низколегированной стали

ОТВОДЫ КРУТОИЗОГНУТЫЕ ТИПА 3D ($R \approx 1,5 DN$)

Конструкция

Carbom and low-alloy steel butt-welding fitting/ Sharply curved bends type 3D ($R \approx 1,5 DN$)/ Design

Дата введения 2003-01-01

1. Область применения

Настоящий стандарт распространяется на бесшовные приварные отводы из углеродистой и низколегированной стали типа $R \approx 1,5 DN$ и $\theta = 90^\circ$ и $\theta = 180^\circ$, изготавливаемые из труб методами штамповки или протяжки по рогаобразному сердечнику.

Область применения отводов-в соответствии с разделом 1 ГОСТ 17380.

Требования пункта 4.1. и раздела 5 являются обязательными, остальные требования - рекомендуемыми.

2. Нормативные ссылки

В настоящем стандарте использована ссылка на ГОСТ 17380-2001. Детали трубопроводов бесшовные приварные из углеродистой и низколегированной стали. Общие технические условия.

3. Определения, обозначения и сокращения

Термины, их определения, обозначения и сокращения по ГОСТ 17380.

4. Конструкция и размеры

4.1. Конструкция и размеры отводов должны соответствовать указанным на рисунке 1 в таблицах 1 и 2.



Рисунок 1

ГОСТ 17375-2001

Таблица 1 – Отводы исполнения 1

Размеры в миллиметрах

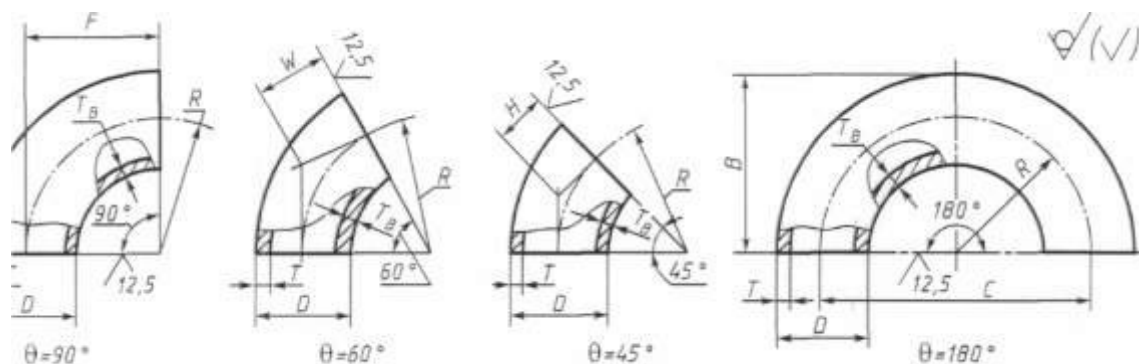
DN	D	T	F = R	H	C	B	Масса, кг, Отвода с θ		
							45°	90°	180°
15	21,3	2,0	28	14	56	38	0,02	0,04	0,08
		3,2					0,03	0,06	0,12
		4,0					0,04	0,07	0,14
20	26,9	2,0	29	14	58	43	0,03	0,06	0,11
		3,2					0,04	0,08	0,17
		4,0					0,06	0,10	0,20
25	33,7	2,3	38	18	76	56	0,05	0,11	0,21
		3,2					0,08	0,16	0,23
		4,5					0,09	0,19	0,38
32	42,4	2,6	48	23	96	69	0,10	0,19	0,39
		3,6					0,13	0,26	0,52
		5,0					0,17	0,35	0,60
40	48,3	2,6	57	29	114	82	0,13	0,26	0,53
		3,6					0,18	0,36	0,72
		5,0					0,24	0,47	0,95
50	60,3	2,9	76	35	152	106	0,25	0,50	0,99
		4,0					0,33	0,67	1,30
		5,6					0,50	0,89	1,80
65	76,1	2,9	95	44	190	133	0,40	0,79	1,60
		5,0					0,72	1,50	2,90
		7,1					0,90	1,80	3,60
80	88,9	3,2	114	51	228	159	0,60	1,20	2,40
		5,6					1,00	2,10	4,10
		8,0					1,40	2,80	5,70
100	114,3	3,6	152	64	304	210	1,20	2,40	4,70
		6,3					2,00	4,00	8,00
		8,8					2,80	5,40	11,00
125	139,7	4,0	190	79	380	260	2,00	4,00	8,00
		6,3					3,10	6,20	12,00
		10,0					4,80	9,60	19,00
150	168,3	4,5	229	95	457	313	3,20	6,50	13,00
		7,1					5,10	10,00	20,00
		11,0					7,70	15,00	31,00
200	219,1	6,3	305	127	610	414	8,00	16,00	32,00
		8,0					9,90	20,00	40,00
		12,5					14,00	31,00	61,00
250	273,0	6,3	381	159	762	518	12,00	25,00	50,00
		10,0					19,00	39,00	78,00
300	323,9	7,1	457	190	914	619	20,00	40,00	80,00
		10,0					28,00	56,00	111,00

Окончание таблицы 1

Размеры в миллиметрах

DN	D	T	F = R	H	C	B	Масса, кг, Отвода с θ		
							45°	90°	180°
350	355,6	8,0	533	222	1066	711	24,00	57,00	114,00
		11,0					39,00	78,00	156,00
400	406,4	8,8	610	254	1220	813	41,00	82,00	165,00
		12,5					58,00	117,00	234,00
450	457,0	10,0	686	286	1372	914	59,00	119,00	237,00
500	508,0	11,0	762	318	1524	1016	81,00	126,00	323,00
600	610,0	12,5	914	381	1828	1219	133,00	266,00	531,00
700	711,0	-	1067	444	2134	1422	-	-	-
800	813,0	-	1219	507	2238	-	-	-	-
900	914,0	-	1372	570	2744	-	-	-	-
1000	1016,0	-	1524	634	3048	-	-	-	-

П р и м е ч а н и я

1. Масса приведена для справок.
2. Отводы с $\theta = 60^\circ$ исполнения 1 не предусматриваются.

Таблица 2 – Отводы исполнения 2

Размеры в миллиметрах

DN	D	T	F = R	W	H	C	B	Масса отвода с $\theta = 90^\circ$, кг
25	32	2,0	38	22	18	76	56	0,1
		2,5						0,2
		3,0						0,2
		3,5						0,2
32	38	2,0	48	28	23	96	69	0,2
		2,5						0,2
		3,0						0,2
		3,5						0,3
		4,0						0,3
40	45	2,5	60	35	25	120	83	0,3
		3,0						0,3
		3,5						0,4
		4,0						0,4
		5,0						0,5
50	57	2,5	75	43	80	150	104	0,4
		3,0						0,5
		3,5						0,6
		4,0						0,7
		4,5						0,7
		5,0						0,8
		5,5						0,9
6,0	1,0							

ГОСТ 17375-2001

Продолжение таблицы 2

Размеры в миллиметрах

DN	D	T	F = R	W	H	C	B	Масса отвода с $\theta = 90^\circ$, кг					
65	76	3,0	100	57	41	200	138	0,8					
		3,5						1,0					
		4,0						1,1					
		4,5						1,3					
		5,0						1,4					
		5,5						1,6					
		6,0						1,7					
		7,0						2,0					
		8,0						2,2					
80	89	3,0	120	69	50	240	165	1,2					
		3,5						1,4					
		4,0						1,5					
		4,5						1,7					
		5,0						1,9					
		5,5						2,1					
		6,0						2,3					
		7,0						2,7					
		8,0						3,0					
100	102	3,5	150	87	62	300	201	2,1					
		4,0						2,4					
		4,5						2,6					
		5,0						2,9					
		6,0						3,4					
		7,0						3,9					
		8,0						4,5					
		9,0						5,0					
		10,0						5,5					
	108	108					3,5	150	87	62	300	204	2,2
							4,0						2,5
							4,5						2,8
							5,0						3,1
							6,0						3,6
							7,0						4,1
							8,0						4,7
							9,0						5,3
							10,0						5,8
114	114	3,5	150	87	62	300	207	2,2					
		4,0						2,6					
		4,5						2,9					
		5,0						3,3					
		6,0						3,8					
		7,0						4,4					
		8,0						5,0					
		9,0						5,7					
		10,0						6,1					
125	133	3,5	190	110	79	380	257	3,3					
		4,0						3,8					
		4,5						4,3					
		5,0						4,8					
		6,0						5,7					
7,0	6,5												

Продолжение таблицы 2

Размеры в миллиметрах

DN	D	T	F = R	W	H	C	B	Масса отвода с $\theta = 90^\circ$, кг	
125	133	8,0	190	110	79	380	257	7,4	
		9,0						8,2	
		10,0						9,1	
		11,0						10,0	
		12,0						11,0	
150	159	4,0	225	130	93	450	305	5,4	
		4,5						6,1	
		5,0						6,7	
		6,0						8,1	
		7,0						9,4	
		8,0						11,0	
		9,0						12,0	
		10,0						13,0	
		11,0						14,0	
		12,0						16,0	
	13,0	17,0							
	14,0	18,0							
	168							4,0	5,6
								4,50	6,4
								5,0	7,1
								6,0	8,5
								7,0	9,8
								8,0	11,2
								9,0	12,5
10,0			14,0						
11,0			15,0						
12,0	16,0								
13,0	17,5								
14,0	19,0								
200	219	5,0	300	173	124	600	410	13,0	
		6,0						15,0	
		7,0						17,0	
		8,0						20,0	
		9,0						22,0	
		10,0						25,0	
		11,0						27,0	
		12,0						29,0	
		13,0						32,0	
		14,0						34,0	
		15,0						37,0	
		16,0						39,0	
		17,0						42,0	
18,0	44,0								
250	273	6,0	375	217	155	750	512	23,0	
		7,0						27,0	
		8,0						31,0	
		9,0						35,0	
		10,0						39,0	
		11,0						43,0	
		12,0						46,0	
		13,0						50,0	
14,0	54,0								

ГОСТ 17375-2001

Продолжение таблицы 2

Размеры в миллиметрах

DN	D	T	F = R	W	H	C	B	Масса отвода с $\theta = 90^\circ$, кг
250	273	15,0	375	217	155	750	512	58,0
		16,0						61,0
		17,0						66,0
		18,0						70,0
		20,0						78,0
		22,0						85,0
300	325	7,0	450	260	186	900	613	39,0
		8,0						45,0
		9,0						50,0
		10,0						56,0
		11,0						61,0
		12,0						66,0
		13,0						72,0
		14,0						77,0
		15,0						82,0
		16,0						87,0
		17,0						92,0
		18,0						96,0
		20,0						107,0
		22,0						118,0
		24,0						130,0
26,0	141,0							
28,0	150,0							
350	377	9,0	525	303	217	1050	714	68,0
		10,0						75,0
		11,0						83,0
		12,0						90,0
		13,0						97,0
		14,0						104,0
		15,0						112,0
		16,0						119,0
		18,0						133,0
		20,0						147,0
		22,0						161,0
		24,0						175,0
		26,0						188,0
		28,0						201,0
		30,0						214,0
32,0	228,0							
400	426	8,0	600	346	248	1200	813	78,0
		9,0						87,0
		10,0						97,0
		11,0						107,0
		12,0						117,0
		13,0						126,0
		14,0						135,0
		15,0						145,0
		16,0						154,0
		17,0						164,0
		18,0						137,0
		20,0						192,0
		22,0						210,0
		24,0						230,0

Продолжение таблицы 2

Размеры в миллиметрах

DN	D	T	F = R	W	H	C	B	Масса отвода с $\theta = 90^\circ$, кг
400	426	26,0	600	346	1200	1200	813	249,0
		28,0						268,0
		30,0						286,0
		32,0						309,0
		34,0						324,0
500	530	9,0	750	433	1500	1500	1015	138,0
		10,0						153,0
		11,0						168,0
		12,0						183,0
		13,0						198,0
		14,0						212,0
		15,0						227,0
		16,0						242,0
		17,0						256,0
		18,0						270,0
		20,0						298,0
		22,0						327,0
		24,0						356,0
		26,0						385,0
		28,0						413,0
		30,0						440,0
32,0	467,0							
34,0	494,0							
36,0	520,0							
600	630	9,0	900	519	1800	1800	1215	198,0
		10,0						219,0
		11,0						245,0
		12,0						261,0
		13,0						282,0
		14,0						302,0
		15,0						324,0
		16,0						345,0
		17,0						366,0
		18,0						387,0
		20,0						429,0
		22,0						471,0
		24,0						513,0
		26,0						554,0
		28,0						595,0
		30,0						636,0
32,0	678,0							
700	720	9,0	1000	577	2000	2000	1360	248,0
		10,0						275,0
		11,0						302,0
		12,0						329,0
		13,0						356,0
		14,0						383,0
		15,0						410,0
		16,0						436,0
		17,0						462,0
		18,0						489,0
		20,0						520,0
		22,0						595,0

Продолжение таблицы 2

Размеры в миллиметрах

DN	D	T	F = R	W	H	C	B	Масса отвода с $\theta = 90^\circ$, кг
700	720	24,0	1000	577	404	2000	1360	647,0
		26,0						698,0
		28,0						750,0
		30,0						801,0
		32,0						852,0
800	820	9,0	1200	693	485	2400	1610	339,0
		10,0						376,0
		11,0						413,0
		12,0						450,0
		13,0						487,0
		14,0						524,0
		15,0						561,0
		16,0						598,0
		17,0						636,0
		18,0						670,0
		20,0						743,0
		22,0						815,0
		24,0						887,0
		26,0						959,0
		28,0						1030,0
30,0	1101,0							
32,0	1171,0							

Примечания

1 Масса приведена для справок.

2 Масса отводов с $\theta = 60^\circ$ и $\theta = 45^\circ$ соответственно в 1,5 и 2 раза меньше, а отводов с $\theta = 80^\circ$ в 2 раза больше указанной.**Примеры условных обозначений:**- отвода с $\theta = 90^\circ$, исполнения 1, $D = 139,7$ мм, $T = 4,0$ мм из стали марки TS4:*Отвод 90-1-139,7 • 4-T54 ГОСТ 17375-2001*- отвода с $\theta = 45^\circ$, исполнения 2, $D = 159$ мм, $T = 4,0$ мм, $T_B = 6,0$ мм из стали марки 20:*Отвод 45-159 - 4/6 ГОСТ 17375-2001*- отвода с $\theta = 90^\circ$, исполнения 2, $D = 57$ мм, $T = 5,0$ мм из стали марки 09Г2С:*Отвод 90-57 5-09Г2С ГОСТ 17375-2001*

- то же, для трубопроводов, подконтрольных органам надзора:

*Отвод П90-57 -5-09Г2С ГОСТ 17375-2001*4.2. По согласованию между изготовителем и потребителем (заказчиком) допускается изготовление отводов исполнения 2 с другими размерами и углами θ .4.3. Допускается изготовление отводов исполнения 2 с увеличенной толщиной стенки в неторцевых сечениях T_B .**5 Технические условия**

Технические условия— по ГОСТ 17380.